

Lockheed Martin
Your Mission Is Ours.™



SIKORSKY
**ARMED
BLACK HAWK®**

Multi-mission Lethality for the Attack

6900 Main Street,
Stratford, Connecticut 06615 USA
+1 (800) WINGED-S (946-4337)
International +1 (203) 386-3029
www.lockheedmartin.com/sikorsky

BLACK HAWK® is a registered trademark of Lockheed Martin Corporation
This Page Does Not Contain Exported Controlled Technical Data. ©2019 Sikorsky, A Lockheed Martin Company 8711 (10/19)





Proven, Reliable
& Versatile

SIKORSKY **ARMED BLACK HAWK**

Multi-mission Flexibility and Firepower
with BLACK HAWK Dependability

The aircraft the world depends on as the preeminent multi-mission utility helicopter can now be equipped by the Original Equipment Manufacturer to provide ATTACK helicopter missions.

We believe that the Black Hawk helicopter can provide a valuable resource to customers who have important, day-to-day vertical-lift needs. The Black Hawk was designed to meet a variety of missions. Now, we can provide a variety of Attack capabilities in an integrated solution.

BLACK HAWK:

More missions, more value than any other medium-class tactical helicopter.





ARMED



EXTERNAL LIFT



COMMAND & CONTROL



SEARCH & RESCUE



VIP TRANSPORT



MEDEVAC



COMBAT ASSAULT



FIREFIGHTING

VERSATILE

Armament Kit Enhances the BLACK HAWK's Multi-mission Capability

Versatile, dependable and rugged are just three reasons why 33+ nations depend on BLACK HAWK helicopters for multi-mission support.

Today's complex and fast-changing operating environments demand an aircraft that is multi-role with proven logistics that meets your budget. Attack-only aircraft are sophisticated platforms designed to fulfill a single mission at a very high-cost; whether you apply that mission or not.

The Armed Black Hawk helicopter's multi-mission lethality enables commanders to utilize 100% of its inherent capability, no matter the mission. Armed or Un-Armed, BLACK HAWKs will work for you.

ARMED BLACK HAWK HELICOPTER

- Flexible firepower configurations that are scalable to meet your threats
- Capability to transport armed vehicles (9000 lbs - 4082 kg)
- Capability to insert and extract teams
- Capability to transport troops and supplies as well as provide the fire power to complete mission
- Safe, Reliable, Survivable, Crashworthy and Ballistically tolerant
- Capable of supporting aircraft self defense & survivability equipment (radar/laser warning) completion



Battlefield Support
for the Soldier

SOLDIER READY

Our helicopters support soldiers and aircraft operators world-wide. They rely upon the Black Hawk for missions, for support and sometimes survival. It's why we ensure, validate, qualify and certify every aircraft and every option installed so that it will perform when you need it most.

STATE OF THE ART MISSION SYSTEM

On the attack, the soldier is provided a state of the art mission system combined with the best armament in the industry. On the defense, the soldiers are provided with equipment that enhances situational awareness on the battlefield, from an unmatched platform that is engineered to be crashworthy and tolerant of ballistic impact.



DUAL M-134 MINI-GUNS

- Electrically powered 3000/4000 RPM
- Capability to be mounted in a fixed forward position or controlled independently for all ranges of motion



DUAL M3M .50 CALIBER GUN

- High firing rate (1025 RPM)
- Capability to be controlled independently for all ranges of motion



KEY DISCRIMINATORS

Advanced Capabilities & Performance for Mission Success

ARMED BLACK HAWK

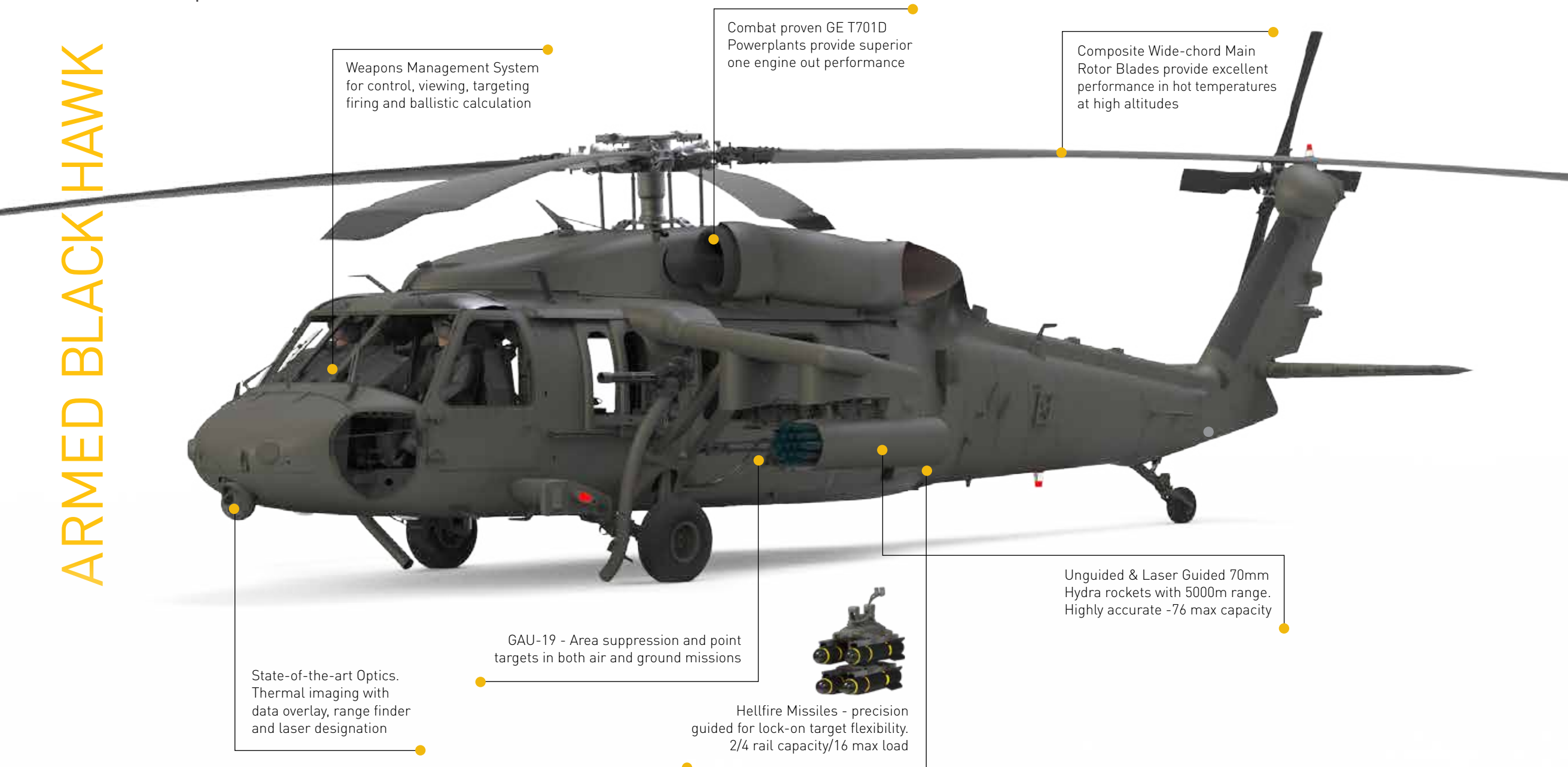

Weapons Management System for control, viewing, targeting firing and ballistic calculation

Combat proven GE T701D Powerplants provide superior one engine out performance

Composite Wide-chord Main Rotor Blades provide excellent performance in hot temperatures at high altitudes

State-of-the-art Optics. Thermal imaging with data overlay, range finder and laser designation

GAU-19 - Area suppression and point targets in both air and ground missions



Hellfire Missiles - precision guided for lock-on target flexibility. 2/4 rail capacity/16 max load

Unguided & Laser Guided 70mm Hydra rockets with 5000m range. Highly accurate -76 max capacity

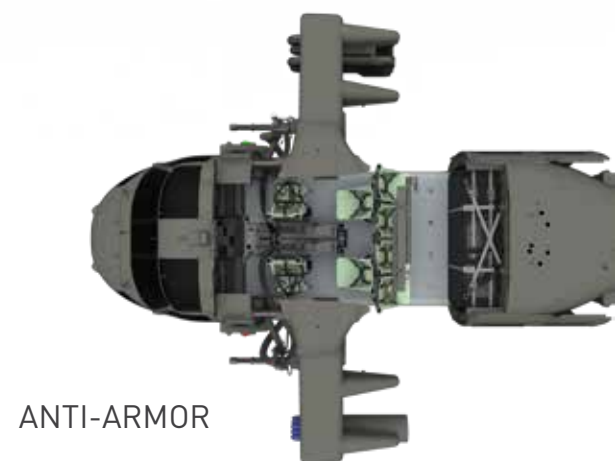

ANTI-ARMOR

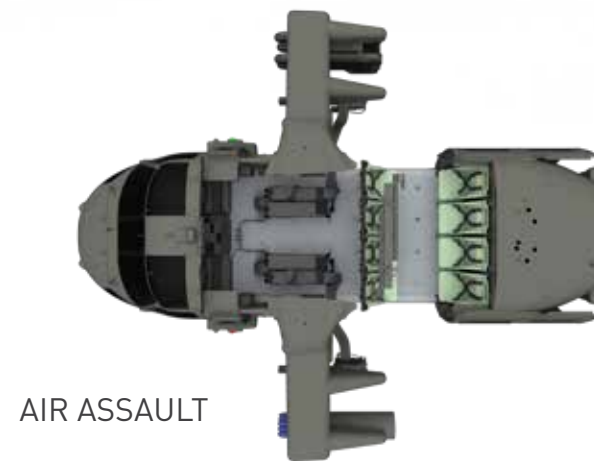

AIR ASSAULT

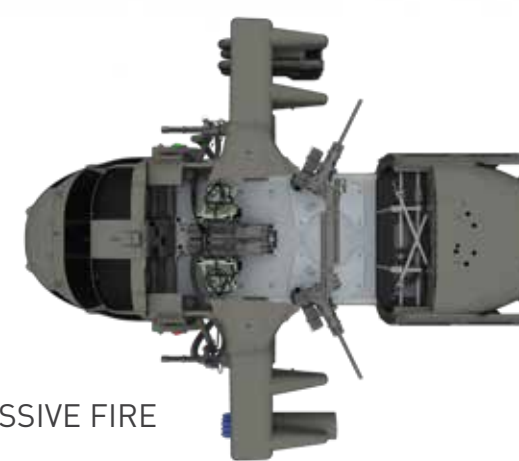

SUPPRESSIVE FIRE

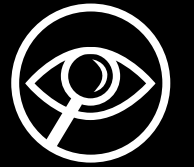

SURVEILLANCE/ ARMED RECONNAISSANCE

Employ the power of the EO/IR sensor during scout missions. Armed with 70mm rockets and fixed-forward or crew-served .50 caliber and 7.62mm machine guns.



AIR ASSAULT

Fill the cabin with 11 troops and two gunners armed with 7.62mm machine guns. Or remove all the seats and load the cabin with cargo. Provide external sling-load operations on the move.



SUPPRESSIVE FIRE

Suppress combatant ground threats with a high-rate of sustained firing from 70mm (2.75in) rockets and .50 caliber forward firing guns.



ARMED ESCORT

Protect ground convoys or coastal boat traffic with 70mm rockets and fixed-forward or crew-served .50 caliber and 7.62mm machine guns.



ANTI-ARMOR

Terminate tanks and other armored vehicles from stand-off distances or on the move. Up to 16 Hellfire missiles.



Top of the Line Weapons Management System



MISSION READY

An easy to use weapons management system that is integrated, not added

Sikorsky has seamlessly integrated a highly-functional, easy to use and maintain Weapons Management System, EO/IR Sensor and Helmet Display and Tracking system. The WMS is integrated directly into the existing Multi-function displays and Flight Management System, providing both pilots control of the weapons system. Pilot and Co-pilot situational awareness is enhanced through the EO/IR sensor and advanced Heads-up-display and Head tracking system that enables any Black Hawk Pilot to put first rounds on target.



WEAPONS MANAGEMENT SYSTEM

- Control and firing of various weapons
- Viewing and managing weapons inventory during flight
- Loading of pre-defined weapons configuration
- Target designations and target paging
- Weapons ballistic calculation



ELECTRO-OPTICAL AND INFRARED SENSOR

- State-of-the-art optics for surveillance to armed reconnaissance missions
- Thermal imaging with data overlay, range finder & laser designation
- Digital video recording integrated into the WMS



HEADS-UP DISPLAY AND HELMET TRACKER SYSTEM

- Presents primary weapons cueing for day and night operations
- Weapon fire control symbology for targeting capability
- Improved crew coordination and communication due to head movement communication between pilots



Trusted, Versatile, Lethal.

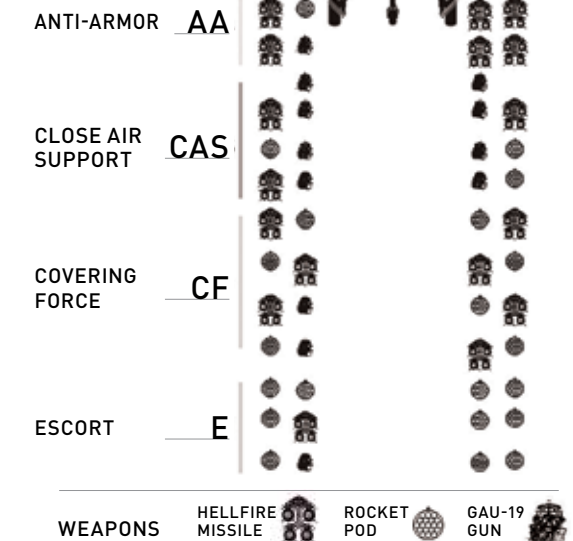

COMBAT READY

Scalable Weapons Configurations to Achieve Your Objective

Designed for combat versatility, the Armed BLACK HAWK helicopter deploys an effective combination of armament systems that are available today. Sikorsky has qualified weapons for the Armed Black Hawk ranging from small to large caliber machine guns, rockets and air to surface missiles.

GAU-19

- 50 caliber, 1300 rounds per minute
- Lightweight, highly reliable, and requires minimal maintenance
- Highly effective against area suppression and point targets, in both air-to-air and air-to-ground missions



HELLFIRE® MISSILES

- Precision guided weapons provide target flexibility and lock-on capability
- Self or third party designation
- 2/4 rail carrying capacity allows for maximum loading of 16 missiles



UNGUIDED & LASER GUIDED ROCKETS

- Supports 70mm Hydra rockets with range up to 5000 meters
- 7/19 shot pods allows for maximum carrying capacity of 76 rockets
- MIL-STD-1760 interface for carrying multiple, highly accurate and cost effective laser guided rockets



THE VALUE OF MULTI-MISSION LETHALITY

The Value of the Armed Black Hawk is in the utilization of a multi-mission helicopter that also has Attack capability. Over 40 years of continuous improvement that has enabled more performance, more capability and more operational cost savings. By selecting a multi-mission Armed Black Hawk, you chose Value. Value that will provide reliable multi-mission support and operational readiness that Attack-only aircraft cannot achieve.

But Value doesn't stop there. Customers that select the multi-mission ABH, also benefit from common logistics, common pilot and aircrew training and a robust maintenance program that is straight forward, accessible and focused on availability and readiness.

UNIT COSTS (\$ M USD)

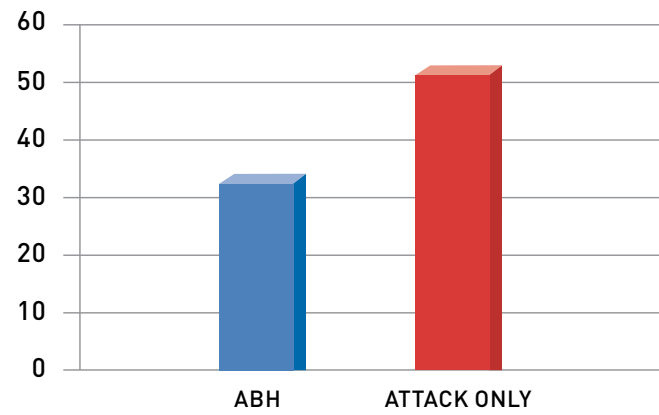

O&M PER HOUR (\$ K USD)

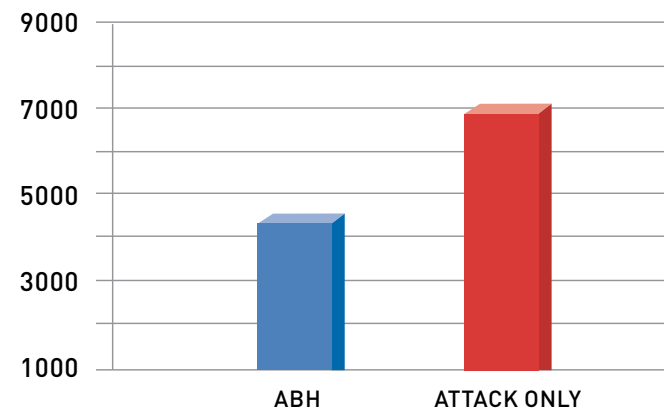

TYPICAL MISSION DISTRIBUTION BY AIRCRAFT MODEL REPRESENTS 30 YEARS OF HELO-SUPPORT

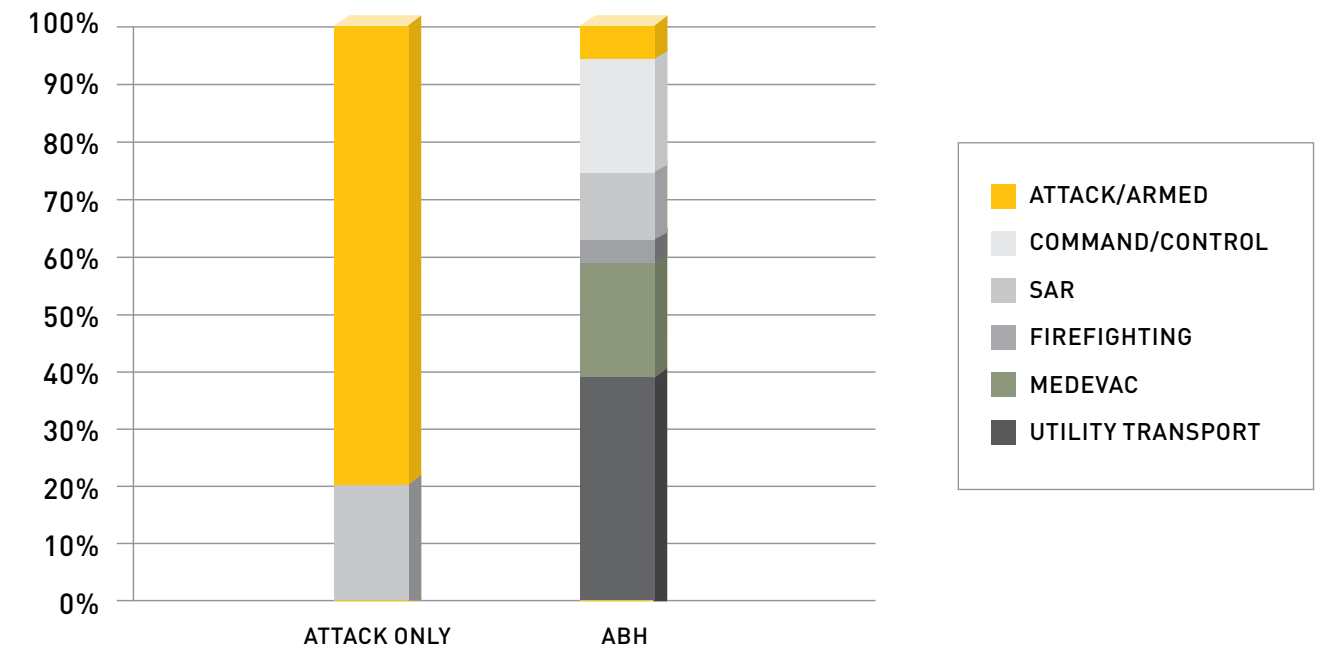

40 Years of
Legendary Performance